

# **DEWALT®**

**DWE4206**

**DWE4207**

**DWE4214**

**DWE4215**

**DWE4216**

**DWE4217**

**DWE4227**

**DWE4235**

**DWE4237**

**DWE4238**

**DWE4246**

**DWE4257**

**[www.DEWALT.com](http://www.DEWALT.com)**



Fig. A

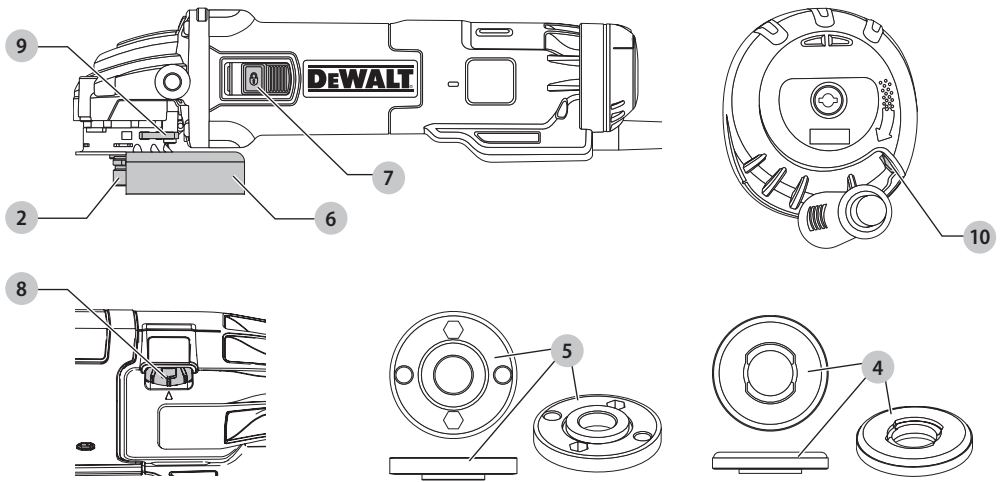

Fig. B

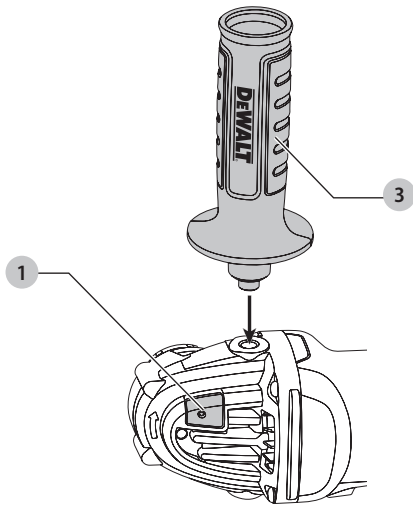

Fig. C

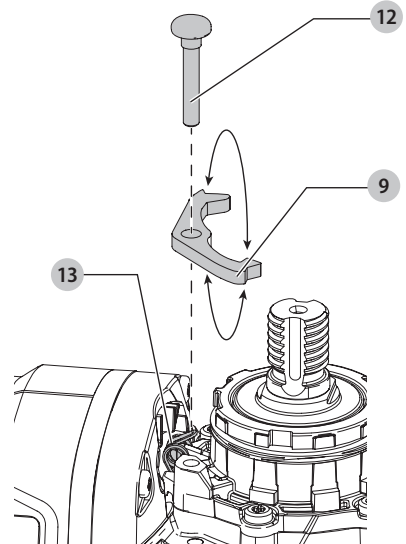

Fig. D

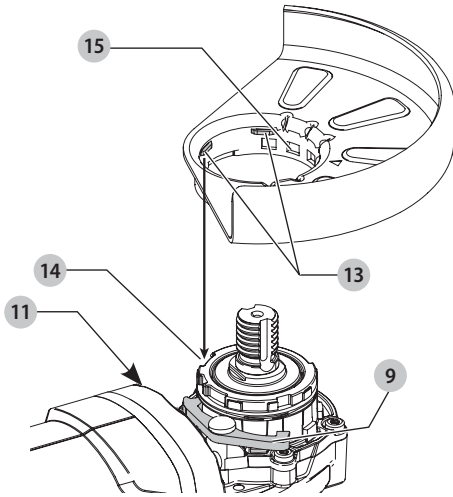

Fig. E

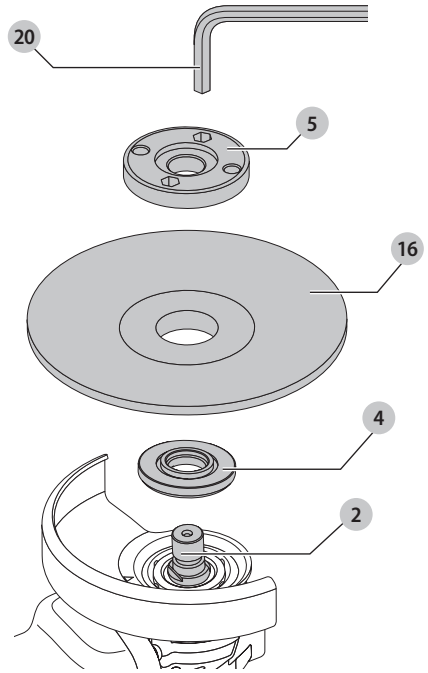

Fig. F

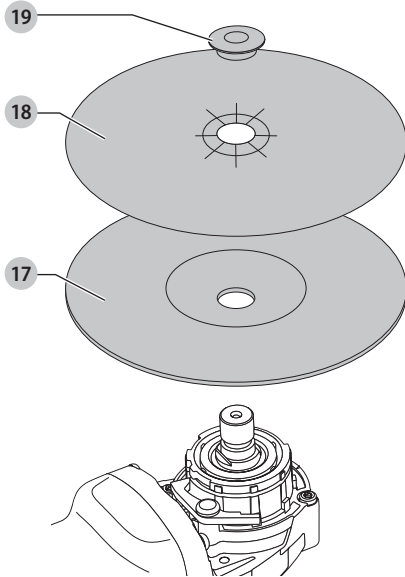
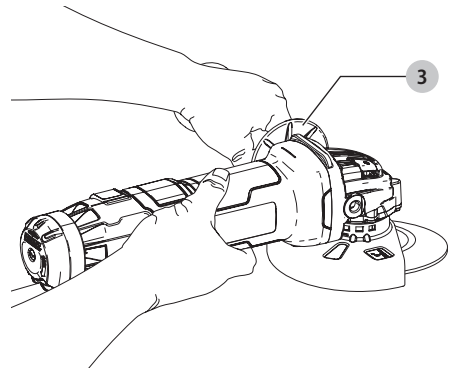

Fig. G



# SMALL ANGLE GRINDERS

## DWE4206, DWE4207, DWE4214, DWE4215, DWE4216, DWE4217, DWE4227, DWE4235, DWE4237, DWE4238, DWE4246, DWE4257

### Congratulations!

You have chosen a DeWALT tool. Years of experience, thorough product development and innovation make DeWALT one of the most reliable partners for professional power tool users.

### Technical Data

		DWE4206 QS/LX	DWE4207 QS/LX	DWE4214	DWE4215	DWE4216	DWE4217
Voltage	V <sub>ac</sub>	230/115	230/115	230	230	230	230
Type		3	3	3	3	3	3
Power input	W	1010	1010	1200	1200	1200	1200
No-load speed	min <sup>-1</sup>	11,000	11,000	11,000	11,000	11,000	11,000
Rated speed	min <sup>-1</sup>	11,000	11,000	11,500	11,500	11,000	11,000
Wheel diameter	mm	115	125	115	115	115	125
Wheel thickness (max)	mm	6.0	6.0	6.0	6.0	6.0	6.0
Spindle diameter		M14	M14	M14	M14	M14	M14
Spindle length	mm	18.5	18.5	18.5	18.5	18.5	18.5
Weight	kg	1.85*	1.85*	1.85*	1.85*	1.85*	1.85*
* weight includes side handle and guard							
Noise and vibration total values (triax vector sum) according to EN 60745-2-3:							
L <sub>PA</sub> (emission sound pressure level)	dB(A)	92.0	92.0	92.0	92.0	92.0	92.0
L <sub>WA</sub> (sound power level)	dB(A)	103.0	103.0	103.0	103.0	103.0	103.0
K (uncertainty for the given sound level)	dB(A)	3	3	3	3	3	3
Surface grinding							
Vibration emission value a <sub>h,AG</sub> =	m/s <sup>2</sup>	8.3	8.3	8.3	8.3	8.3	8.3
Uncertainty K =	m/s <sup>2</sup>	1.5	1.5	1.5	1.5	1.5	1.5
Disc sanding							
Vibration emission value a <sub>h,DS</sub> =	m/s <sup>2</sup>	3.0	3.0	3.0	3.0	3.0	3.0
Uncertainty K =	m/s <sup>2</sup>	1.5	1.5	1.5	1.5	1.5	1.5



**CAUTION:** Working with the wire brush or the abrasive cutting can lead to different vibration levels!

The vibration emission level given in this information sheet has been measured in accordance with a standardised test given in EN60745 and may be used to compare one tool with another. It may be used for a preliminary assessment of exposure.



**WARNING:** The declared vibration emission level represents the main applications of the tool. However if the tool is used for different applications, with different accessories or poorly maintained, the vibration emission may differ. This may significantly increase the exposure level over the total working period.

An estimation of the level of exposure to vibration should also take into account the times when the tool is switched off or when it is running but not actually doing the job. This may significantly reduce the exposure level over the total working period.

Identify additional safety measures to protect the operator from the effects of vibration such as: maintain the tool and the accessories, keep the hands warm, organisation of work patterns.

ENGLISH

		DWE4227	DWE4235	DWE4237	DWE4238	DWE4246	DWE4257
Voltage	V <sub>Ac</sub>	230	230	230	230	230	230
Type		3	3	3	1	1	1
Power input	W	1200	1400	1400	1400	1200	1500
No-load speed	min <sup>-1</sup>	11000	11500	11500	9300	2800-10000	2800-10000
Rated speed	min <sup>-1</sup>	11000	11500	11500	9300	10000	10000
Wheel diameter	mm	125	125	125	150	115	125
Wheel thickness (max)	mm	6.0	6.0	6.0	6.0	6.0	6.0
Spindle diameter		M14	M14	M14	M14	M14	M14
Spindle length	mm	18.5	18.5	18.5	18.5	20.1	20.1
Weight	kg	1.85*	1.85*	1.85*	2.5*	2.5*	2.5*
* weight includes side handle and guard							
Noise and vibration total values (triax vector sum) according to EN 60745-2-3:							
L <sub>PA</sub> (emission sound pressure level)	dB(A)	92.0	92.0	92.0	92.0	92.0	92.0
L <sub>WA</sub> (sound power level)	dB(A)	103.0	103.0	103.0	103.0	103.0	103.0
K (uncertainty for the given sound level)	dB(A)	3	3	3	3	3	3
Surface grinding							
Vibration emission value a <sub>h,AG</sub> =	m/s <sup>2</sup>	8.3	8.3	8.3	8.3	8.3	8.3
Uncertainty K =	m/s <sup>2</sup>	1.5	1.5	1.5	1.5	1.5	1.5
Disc sanding							
Vibration emission value a <sub>h,DS</sub> =	m/s <sup>2</sup>	3.0	3.0	3.0	–	3.0	3.0
Uncertainty K =	m/s <sup>2</sup>	1.5	1.5	1.5	–	1.5	1.5

 **CAUTION:** Working with the wire brush or the abrasive cutting can lead to different vibration levels!

**EC-Declaration of Conformity  
Machinery Directive**



**Small Angle Grinders**

**DWE4206, DWE4207, DWE4214, DWE4215, DWE4216,  
DWE4217, DWE4227, DWE4235, DWE4237, DWE4238,  
DWE4246, DWE4257**

DEWALT declares that these products described under

**Technical Data** are in compliance with:

2006/42/EC, EN60745-1:2009+A11:209, EN60745-2-3:2011+A2:2013+A11:2014 +A12:2014+A13:2015.

These products also comply with Directive 2014/30/EU and 2011/65/EU. For more information, please contact DEWALT at the following address or refer to the back of the manual.

The undersigned is responsible for compilation of the technical file and makes this declaration on behalf of DEWALT.

Markus Rompel  
Director Engineering  
DEWALT, Richard-Klinger-Straße 11,  
D-65510, Idstein, Germany  
07.06.2018



**WARNING:** To reduce the risk of injury, read the instruction manual.

**Definitions: Safety Guidelines**

The definitions below describe the level of severity for each signal word. Please read the manual and pay attention to these symbols.



**DANGER:** Indicates an imminently hazardous situation which, if not avoided, **will** result in **death or serious injury**.



**WARNING:** Indicates a potentially hazardous situation which, if not avoided, **could** result in **death or serious injury**.



**CAUTION:** Indicates a potentially hazardous situation which, if not avoided, **may** result in **minor or moderate injury**.

**NOTICE:** Indicates a practice **not related to personal injury** which, if not avoided, **may** result in **property damage**.



Denotes risk of electric shock.



Denotes risk of fire.

## General Power Tool Safety Warnings



**WARNING:** Read all safety warnings and all instructions. Failure to follow the warnings and instructions may result in electric shock, fire and/or serious injury.

### SAVE ALL WARNINGS AND INSTRUCTIONS FOR FUTURE REFERENCE

The term "power tool" in the warnings refers to your mains-operated (corded) power tool or battery-operated (cordless) power tool.

#### 1) Work area safety

- Keep work area clean and well lit.** Cluttered or dark areas invite accidents.
- Do not operate power tools in explosive atmospheres, such as in the presence of flammable liquids, gases or dust.** Power tools create sparks which may ignite the dust or fumes.
- Keep children and bystanders away while operating a power tool.** Distractions can cause you to lose control.

#### 2) Electrical safety

- Power tool plugs must match the outlet. Never modify the plug in any way. Do not use any adapter plugs with earthed (grounded) power tools.**  
Unmodified plugs and matching outlets will reduce risk of electric shock.
- Avoid body contact with earthed or grounded surfaces such as pipes, radiators, ranges and refrigerators.** There is an increased risk of electric shock if your body is earthed or grounded.
- Do not expose power tools to rain or wet conditions.**  
Water entering a power tool will increase the risk of electric shock.
- Do not abuse the cord. Never use the cord for carrying, pulling or unplugging the power tool. Keep cord away from heat, oil, sharp edges or moving parts.** Damaged or entangled cords increase the risk of electric shock.
- When operating a power tool outdoors, use an extension cord suitable for outdoor use.** Use of a cord suitable for outdoor use reduces the risk of electric shock.
- If operating a power tool in a damp location is unavoidable, use a residual current device (RCD) protected supply.** Use of an RCD reduces the risk of electric shock.

#### 3) Personal safety

- Stay alert, watch what you are doing and use common sense when operating a power tool. Do not use a power tool while you are tired or under the influence of drugs, alcohol or medication.** A moment of inattention while operating power tools may result in serious personal injury.
- Use personal protective equipment. Always wear eye protection.** Protective equipment such as dust mask,

non-skid safety shoes, hard hat, or hearing protection used for appropriate conditions will reduce personal injuries.

- Prevent unintentional starting. Ensure the switch is in the off position before connecting to power source and/or battery pack, picking up or carrying the tool.** Carrying power tools with your finger on the switch or energising power tools that have the switch on invites accidents.
- Remove any adjusting key or wrench before turning the power tool on.** A wrench or a key left attached to a rotating part of the power tool may result in personal injury.
- Do not overreach. Keep proper footing and balance at all times.** This enables better control of the power tool in unexpected situations.
- Dress properly. Do not wear loose clothing or jewellery. Keep your hair, clothing and gloves away from moving parts.** Loose clothes, jewellery or long hair can be caught in moving parts.
- If devices are provided for the connection of dust extraction and collection facilities, ensure these are connected and properly used.** Use of dust collection can reduce dust-related hazards.

#### 4) Power tool use and care

- Do not force the power tool. Use the correct power tool for your application.** The correct power tool will do the job better and safer at the rate for which it was designed.
- Do not use the power tool if the switch does not turn it on and off.** Any power tool that cannot be controlled with the switch is dangerous and must be repaired.
- Disconnect the plug from the power source and/or the battery pack from the power tool before making any adjustments, changing accessories, or storing power tools.** Such preventive safety measures reduce the risk of starting the power tool accidentally.
- Store idle power tools out of the reach of children and do not allow persons unfamiliar with the power tool or these instructions to operate the power tool.** Power tools are dangerous in the hands of untrained users.
- Maintain power tools. Check for misalignment or binding of moving parts, breakage of parts and any other condition that may affect the power tool's operation. If damaged, have the power tool repaired before use.** Many accidents are caused by poorly maintained power tools.
- Keep cutting tools sharp and clean.** Properly maintained cutting tools with sharp cutting edges are less likely to bind and are easier to control.
- Use the power tool, accessories and tool bits etc., in accordance with these instructions taking into account the working conditions and the work to be performed.** Use of the power tool for operations different from those intended could result in a hazardous situation.

## 5) Service

- a) *Have your power tool serviced by a qualified repair person using only identical replacement parts. This will ensure that the safety of the power tool is maintained.*

## ADDITIONAL SPECIFIC SAFETY RULES

### Safety Instructions for All Operations

- a) *This power tool is intended to function as a grinder, sander (DWE4238 is excluded), wire brush or cut-off tool. Read all safety warnings, instructions, illustrations and specifications provided with this power tool. Failure to follow all instructions listed below may result in electric shock, fire and/or serious injury.*
- b) *Operations such as polishing and sanding (DWE4238) are not recommended to be performed with this power tool. Operations for which the power tool was not designed may create a hazard and cause personal injury.*
- c) *Do not use accessories which are not specifically designed and recommended by the tool manufacturer. Just because the accessory can be attached to your power tool, it does not assure safe operation.*
- d) *The rated speed of the accessory must be at least equal to the maximum speed marked on the power tool. Accessories running faster than their rated speed can break and fly apart.*
- e) *The outside diameter and the thickness of your accessory must be within the capacity rating of your power tool. Incorrectly sized accessories can not be adequately guarded or controlled.*
- f) *Threaded mounting of accessories must match the grinder spindle thread. For accessories mounted by flanges, the arbour hole of the accessory must fit the locating diameter of the flange. Accessories that do not match the mounting hardware of the power tool will run out of balance, vibrate excessively and may cause loss of control.*
- g) *Do not use a damaged accessory. Before each use inspect the accessory such as abrasive wheel for chips and cracks, backing pad for cracks, tear or excess wear, wire brush for loose or cracked wires. If power tool or accessory is dropped, inspect for damage or install an undamaged accessory. After inspecting and installing an accessory, position yourself and bystanders away from the plane of the rotating accessory and run the power tool at maximum no-load speed for one minute. Damaged accessories will normally break apart during this test time.*
- h) *Wear personal protective equipment. Depending on application, use face shield, safety goggles or safety glasses. As appropriate, wear dust mask, hearing protectors, gloves and workshop apron capable of stopping small abrasive or workpiece fragments. The eye protection must be capable of stopping flying*

*debris generated by various operations. The dust mask or respirator must be capable of filtering particles generated by your operation. Prolonged exposure to high intensity noise may cause hearing loss.*

- i) *Keep bystanders a safe distance away from work area. Anyone entering the work area must wear personal protective equipment. Fragments of workpiece or of a broken accessory may fly away and cause injury beyond immediate area of operation.*
- j) *Hold the power tool by insulated gripping surfaces only, when performing an operation where the cutting accessory may contact hidden wiring or its own cord. Cutting accessory contacting a "live" wire may make exposed metal parts of the power tool "live" and could give the operator an electrical shock.*
- k) *Position the cord clear of the spinning accessory. If you lose control, the cord may be cut or snagged and your hand or arm may be pulled into the spinning accessory.*
- l) *Never lay the power tool down until the accessory has come to a complete stop. The spinning accessory may grab the surface and pull the power tool out of your control.*
- m) *Do not run the power tool while carrying it at your side. Accidental contact with the spinning accessory could snag your clothing, pulling the accessory into your body.*
- n) *Regularly clean the power tool's air vents. The motor's fan will draw the dust inside the housing and excessive accumulation of powdered metal may cause electrical hazards.*
- o) *Do not operate the power tool near flammable materials. Sparks could ignite these materials.*
- p) *Do not use accessories that require liquid coolants. Using water or other liquid coolants may result in electrocution or shock.*
- q) *Do not use Type 11 (flaring cup) wheels on this tool. Using inappropriate accessories can result in injury.*
- r) *Always use side handle. Tighten the handle securely. The side handle should always be used to maintain control of the tool at all times.*

## FURTHER SAFETY INSTRUCTIONS FOR ALL OPERATIONS

### Causes and Operator Prevention of Kickback

*Kickback is a sudden reaction to a pinched or snagged rotating wheel, backing pad, brush or any other accessory. Pinching or snagging causes rapid stalling of the rotating accessory which in turn causes the uncontrolled power tool to be forced in the direction opposite of the accessory's rotation at the point of the binding.*

*For example, if an abrasive wheel is snagged or pinched by the workpiece, the edge of the wheel that is entering into the pinch point can dig into the surface of the material causing the wheel*



to climb out or kick out. The wheel may either jump toward or away from the operator, depending on direction of the wheel's movement at the point of pinching. Abrasive wheels may also break under these conditions.

Kickback is the result of tool misuse and/or incorrect operating procedures or conditions and can be avoided by taking proper precautions as given below:

- a) **Maintain a firm grip on the power tool and position your body and arm to allow you to resist kickback forces. Always use auxiliary handle, if provided, for maximum control over kickback or torque reaction during start up.** The operator can control torque reaction or kickback forces, if proper precautions are taken.
- b) **Never place your hand near the rotating accessory.** Accessory may kickback over your hand.
- c) **Do not position your body in the area where power tool will move if kickback occurs.** Kickback will propel the tool in direction opposite to the wheel's movement at the point of snagging.
- d) **Use special care when working corners, sharp edges etc. Avoid bouncing and snagging the accessory.** Corners, sharp edges or bouncing have a tendency to snag the rotating accessory and cause loss of control or kickback.
- e) **Do not attach a saw chain woodcarving blade or toothed saw blade.** Such blades create frequent kickback and loss of control.

## Safety Warnings Specific for Grinding and Abrasive Cutting-Off Operations

- a) **Use only wheel types that are recommended for your power tool and the specific guard designed for the selected wheel.** Wheels for which the power tool was not designed cannot be adequately guarded and are unsafe.
- b) **The grinding surface of centre depressed wheels must be mounted below the plane of the guard lip.** An improperly mounted wheel that projects through the plane of the guard lip cannot be adequately protected.
- c) **The guard must be securely attached to the power tool and positioned for maximum safety, so the least amount of wheel is exposed towards the operator.** The guard helps to protect the operator from broken wheel fragments, accidental contact with wheel and sparks that could ignite clothing.
- d) **Wheels must be used only for recommended applications. For example: do not grind with the side of cut-off wheel.** Abrasive cut-off wheels are intended for peripheral grinding, side forces applied to these wheels may cause them to shatter.
- e) **Always use undamaged wheel flanges that are of correct size and shape for your selected wheel.** Proper wheel flanges support the wheel thus reducing the possibility of wheel breakage. Flanges for cut-off wheels may be different from grinding wheel flanges.

- f) **Do not use worn down wheels from larger power tools.** Wheel intended for larger power tool is not suitable for the higher speed of a smaller tool and may burst.

## Additional Safety Warnings Specific for Abrasive Cutting-Off Operations

- a) **Do not "jam" the cut-off wheel or apply excessive pressure. Do not attempt to make an excessive depth of cut.** Overstressing the wheel increases the loading and susceptibility to twisting or binding of the wheel in the cut and the possibility of kickback or wheel breakage.
- b) **Do not position your body in line with and behind the rotating wheel.** When the wheel, at the point of operations, is moving away from your body, the possible kickback may propel the spinning wheel and the power tool directly at you.
- c) **When wheel is binding or when interrupting a cut for any reason, switch off the power tool and hold the power tool motionless until the wheel comes to a complete stop. Never attempt to remove the cut-off wheel from the cut while the wheel is in motion otherwise kickback may occur.** Investigate and take corrective action to eliminate the cause of wheel binding.
- d) **Do not restart the cutting operation in the workpiece. Let the wheel reach full speed and carefully re-enter the cut.** The wheel may bind, walk up or kickback if the power tool is restarted in the workpiece.
- e) **Support panels or any oversized workpiece to minimize the risk of wheel pinching and kickback.** Large workpieces tend to sag under their own weight. Supports must be placed under the workpiece near the line of cut and near the edge of the workpiece on both sides of the wheel.
- f) **Use extra caution when making a "pocket cut" into existing walls or other blind areas.** The protruding wheel may cut gas or water pipes, electrical wiring or objects that can cause kickback.

## Safety Warnings Specific for Sanding Operations

- a) **Do not use excessively oversized sanding disc paper. Follow manufacturer's recommendations, when selecting sanding paper.** Larger sanding paper extending beyond the sanding pad presents a laceration hazard and may cause snagging, tearing of the disc or kickback.

## Safety Warnings Specific for Wire Brushing Operations

- a) **Be aware that wire bristles are thrown by the brush even during ordinary operation. Do not overstress the wires by applying excessive load to the brush.** The wire bristles can easily penetrate light clothing and/or skin.

- b) **If the use of a guard is recommended for wire brushing, do not allow any interference of the wire wheel or brush with the guard.** Wire wheel or brush may expand in diameter due to work and centrifugal forces.

## Additional Safety Rules for Grinders

- Threaded mounting of accessories must match the grinder spindle thread. For accessories mounted by flanges, the arbor hole of the accessory must fit the locating diameter of the flange. Accessories that do not match the mounting hardware of the power tool will run out of balance, vibrate excessively and may cause loss of control.
- The grinding surface of the centre depressed wheels must be mounted below the plane of the guard lip. An improperly mounted wheel that projects through the plane of the guard lip cannot be adequately protected.



**WARNING:** We recommend the use of a residual current device with a residual current rating of 30mA or less.

## Residual Risks

In spite of the application of the relevant safety regulations and the implementation of safety devices, certain residual risks cannot be avoided. These are:

- Impairment of hearing.
- Risk of personal injury due to flying particles.
- Risk of burns due to accessories becoming hot during operation.
- Risk of personal injury due to prolonged use.
- Risk of dust from hazardous substances.

## Electrical Safety

The electric motor has been designed for one voltage only. Always check that the power supply corresponds to the voltage on the rating plate.



Your DEWALT tool is double insulated in accordance with EN60745; therefore no earth wire is required.

If the supply cord is damaged, it must be replaced by a specially prepared cord available through the DEWALT service organisation.

## Mains Plug Replacement (U.K. & Ireland Only)

If a new mains plug needs to be fitted:

- Safely dispose of the old plug.
- Connect the brown lead to the live terminal in the plug.
- Connect the blue lead to the neutral terminal.



**WARNING:** No connection is to be made to the earth terminal.

Follow the fitting instructions supplied with good quality plugs. Recommended fuse: 13 A.

## Using an Extension Cable

An extension cord should not be used unless absolutely necessary. Use an approved extension cable suitable for the power input of your charger (see **Technical Data**). The minimum conductor size is 1.5 mm<sup>2</sup>; the maximum length is 30 m.

When using a cable reel, always unwind the cable completely.

## Package Contents

The package contains:

- 1 Angle grinder
- 1 Guard
- 1 Side handle
- 1 Backing flange
- 1 Threaded clamp nut
- 1 Keyless clamp nut (DWE4246, DWE4257)
- 1 Hex key
- 1 Instruction manual
- Check for damage to the tool, parts or accessories which may have occurred during transport.
- Take the time to thoroughly read and understand this manual prior to operation.

## Markings on Tool

The following pictograms are shown on the tool:



Read instruction manual before use.



Wear ear protection.



Wear eye protection.

## Date Code Position (Fig. D)

The date code **11**, which also includes the year of manufacture, is printed into the housing.

Example:

2018 XX XX  
Year of Manufacture

## Description (Fig. A, B)



**WARNING:** Never modify the power tool or any part of it. Damage or personal injury could result.

- 1 Spindle lock button
- 2 Spindle
- 3 Side handle
- 4 Backing flange
- 5 Clamp nut
- 6 Guard
- 7 Slider switch
- 8 Variable speed dial (DWE4246, DWE4257)
- 9 Guard release lever
- 10 Dust ejection system

## Intended Use

Your heavy-duty small angle grinder has been designed for professional grinding, sanding (DWE4238 is excluded), wire brushing and cutting applications.

**DO NOT** use grinding wheels other than centre depressed wheels and flap discs.

**DO NOT** use under wet conditions or in the presence of flammable liquids or gases.

Your heavy-duty angle grinder is a professional power tool.

**DO NOT** let children come into contact with the tool.

Supervision is required when inexperienced operators use this tool.

- **Young children and the infirm.** This appliance is not intended for use by young children or infirm persons without supervision.
- This product is not intended for use by persons (including children) suffering from diminished physical, sensory or mental abilities; lack of experience, knowledge or skills unless they are supervised by a person responsible for their safety. Children should never be left alone with this product.

## Anti-vibration Side Handle

The anti-vibration side handle offers added comfort by absorbing the vibrations caused by the tool.

## Dust Ejection System (Fig. A)

The dust ejection system **10** prevents dust pile-up around the guard and motor inlet, and minimises the amount of dust entering the motor housing.

## Soft Start Feature

DWE4206, DWE4207, DWE4216, DWE4217, DWE4227, DWE4237, DWE4238, DWE4246, DWE4257

The soft start feature allows a slow speed build-up to avoid an initial jerk when starting. This feature is particularly useful when working in confined spaces.

## No-Volt

DWE4206, DWE4207, DWE4216, DWE4217, DWE4227, DWE4237, DWE4238, DWE4246, DWE4257

The No-volt function stops the grinder restarting without the switch being cycled if there is a break in the power supply.

## Electronic Clutch

DWE4227, DWE4246, DWE4257

The electronic torque limiting clutch reduces the maximum torque reaction transmitted to the operator in case of jamming of a disc. This feature also prevents the gearing and electric motor from stalling. The torque limiting clutch has been factory-set and cannot be adjusted.

## ASSEMBLY AND ADJUSTMENTS

**!** **WARNING:** To reduce the risk of serious personal injury, turn tool off and disconnect tool from power source before making any adjustments or removing/installing attachments or accessories. Be sure the

trigger switch is in the OFF position. An accidental start-up can cause injury.

## Attaching Side Handle (Fig. B)

**!** **WARNING:** Before using the tool, check that the handle is tightened securely.

Screw the side handle **3** tightly into one of the holes on either side of the gear case. The side handle should always be used to maintain control of the tool at all times.

## Guards

**!** **CAUTION:** Guards must be used with all grinding wheels, cutting wheels, sanding flap discs, wire brushes, and wire wheels. The tool may be used without a guard only when sanding with conventional sanding discs. Refer to Figure A to see guards provided with the unit. Some applications may require purchasing the correct guard from your local dealer or authorized service centre.

**NOTE:** Edge grinding and cutting can be performed with Type 27 wheels designed and specified for this purpose; 6.35 mm thick wheels are designed for surface grinding while thinner Type 27 wheels need to be examined for the manufacturer's label to see if they can be used for surface grinding or only edge grinding/cutting. A Type 1 guard must be used for any wheel where surface grinding is forbidden. Cutting can also be performed by using a Type 41 wheel and a Type 1 guard.

**NOTE:** See the **Grinding and Cutting Accessory Chart** to select the proper guard / accessory combination.

## Adjusting and Mounting Guard (Fig. C, D)

**!** **CAUTION:** Turn unit off and unplug the tool before making any adjustments or removing or installing attachments or accessories.

**!** **CAUTION:** BEFORE operating the tool, identify which guard adjustment option your tool is set to.

### Adjustment Options

For guard adjustment, the guard release lever **9** engages one of the alignment holes **15** on the guard collar using a ratcheting feature. Your grinder offers two options for this adjustment.

- **One-Touch™:** In this position the engaging face is slanted and will ride over to the next alignment hole when guard is rotated in a clockwise direction (spindle facing user) but self-locks in the anti-clockwise direction.
- **Two-Touch™:** In this position the engaging face is straight and squared off. It will NOT ride over to the next alignment hole unless guard release lever is pressed and held while simultaneously rotating the guard in either a clockwise or anti-clockwise direction (spindle facing user).

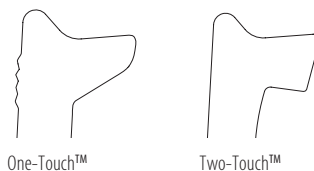

## Setting Guard Adjustment Options

To adjust the guard release lever **9** for desired adjustment option:

1. Remove screw **12** using a T20 bit.
2. Remove the guard release lever taking note of the spring position. Choose the end of the lever for the desired adjustment option. One-touch will use the slanted end of the lever **9** to engage the alignment holes **15** on the guard collar. Two-touch will use the squared end to engage the alignment holes **15** on the guard collar.
3. Replace the lever, positioning the chosen end under the spring **13**. Ensure the lever is in proper contact with the spring.
4. Replace screw and torque to 2.0-3.0N-m. Ensure proper installation with spring return function by depressing guard release lever **9**.

## Mounting Guard (Fig. D)

 **CAUTION:** Prior to mounting guard, ensure the screw, lever, and spring are fitted correctly before mounting the guard.

1. With the spindle facing the operator, press and hold the guard release lever **9**.
2. Align the lugs **13** on the guard with the slots **14** on the gear case.
3. Push the guard down until the guard lugs engage and rotate them in the groove on the gear case hub. Release the guard release lever.
4. To position the guard:

**One-Touch™:** Rotate the guard clockwise into the desired working position. Press and hold the guard release lever **9** release lever to rotate the guard in the anti-clockwise direction.

**Two-Touch™:** Press and hold the guard release lever **9**. Rotate the guard clockwise or anti-clockwise into the desired working position.

**NOTE:** The guard body should be positioned between the spindle and the operator to provide maximum operator protection.

The guard release lever should snap into one of the alignment holes **15** on the guard collar. This ensures that the guard is secure.

5. To remove the guard, follow steps 1–3 of these instructions in reverse.

## Flanges and Wheels

### Mounting Non-Hubbed Wheels (Fig. E)

 **WARNING:** Failure to properly seat the flange/ clamp nut/ wheel could result in serious injury (or damage to the tool or wheel).

 **CAUTION:** Included flanges must be used with depressed centre Type 27 and Type 42 grinding wheels and Type 41 cutting wheels. See the **Grinding and Cutting Accessory Chart** for more information.

 **WARNING:** A closed, two-sided cutting wheel guard is required when using cutting wheels.

 **WARNING:** Use of a damaged flange or guard or failure to use proper flange and guard can result in injury due to wheel breakage and wheel contact. See the **Grinding and Cutting Accessory Chart** for more information.

1. Place the tool on a table, guard up.
2. Install the unthreaded backing flange **4** on spindle **2** with the raised centre (pilot) facing the wheel.
3. Place wheel **16** against the backing flange, centring the wheel on the raised centre (pilot) of the backing flange.
4. While depressing the spindle lock button and with the hex depressions facing away from the wheel, thread the clamp nut **5** on spindle so that the lugs engage the two slots in the spindle.
5. While depressing the spindle lock button, tighten the clamp nut **5**:
  - a. Tighten standard clamp nut using a wrench **20**.
  - b. Tighten a keyless clampnut by hand. (Only use a keyless clampnut if it is in perfect condition.) Refer to **Package Contents** to see clampnut details.
6. To remove the wheel, depress the spindle lock button and loosen the clamp nut.

### Mounting Sanding Backing Pads (Fig. F)

**NOTE:** Use of a guard with sanding discs that use backing pads, often called fiber resin discs, is not required. Since a guard is not required for these accessories, the guard may or may not fit correctly if used.

 **WARNING:** Failure to properly seat the flange/ clamp nut/ wheel could result in serious injury (or damage to the tool or wheel).

 **WARNING:** Proper guard must be reinstalled for grinding wheel, cutting wheel, sanding flap disc, wire brush or wire wheel applications after sanding applications are complete.

1. Place or appropriately thread backing pad **17** on the spindle.
2. Place the sanding disc **18** on the backing pad **17**.
3. While depressing spindle lock **1**, thread clamp nut **19** on spindle, piloting the raised hub on the clamp nut into the centre of sanding disc and backing pad.
4. Tighten the clamp nut by hand. Then depress the spindle lock button while turning the sanding disc until the sanding disc and clamp nut are snug.
5. To remove the wheel, grasp and turn the backing pad and sanding pad while depressing the spindle lock button.

### Mounting and Removing Hubbed Wheels (Fig. A, B)

Hubbed wheels install directly on the M14 threaded spindle. Thread of accessory must match thread of spindle.

1. Remove backing flange by pulling away from tool.
2. Thread the wheel on the spindle **2** by hand.
3. Depress the spindle lock button **1** and use a wrench to tighten the hub of the wheel.
4. Reverse the above procedure to remove the wheel.

**NOTICE:** Failure to properly seat the wheel before turning the tool on may result in damage to the tool or the wheel.

## Mounting Wire Cup Brushes and Wire Wheels (Fig. A, B)

 **WARNING:** Failure to properly seat the flange/ clamp nut/ wheel could result in serious injury (or damage to the tool or wheel).

 **CAUTION:** To reduce the risk of personal injury, wear work gloves when handling wire brushes and wheels. They can become sharp.

 **CAUTION:** To reduce the risk of damage to the tool, wheel or brush must not touch guard when mounted or while in use. Undetectable damage could occur to the accessory, causing wires to fragment from accessory wheel or cup.

Wire cup brushes or wire wheels install directly on the threaded spindle without the use of flanges. Use only wire brushes or wheels provided with a M14 threaded hub. These accessories are available at extra cost from your local dealer or authorised service centre.

1. Place the tool on a table, guard up.
2. Thread the wheel on the spindle by hand.
3. Depress spindle lock button  and use a wrench on the hub of the wire wheel or brush to tighten the wheel.
4. To remove the wheel, reverse the above procedure.

**NOTICE:** To reduce the risk of damage to the tool, properly seat the wheel hub before turning the tool on.

## Prior to Operation

- Install the guard and appropriate disc or wheel. Do not use excessively worn discs or wheels.
- Be sure the inner and outer flange are mounted correctly. Follow the instructions given in the **Grinding and Cutting Accessory Chart**.
- Make sure the disc or wheel rotates in the direction of the arrows on the accessory and the tool.
- Do not use a damaged accessory. Before each use inspect the accessory such as abrasive wheels for chips and cracks, backing pad for cracks, tear or excess wear, wire brush for loose or cracked wires. If power tool or accessory is dropped, inspect for damage or install an undamaged accessory. After inspecting and installing an accessory, position yourself and bystanders away from the plane of the rotating accessory and run the power tool at maximum no-load speed for one minute. Damaged accessories will normally break apart during this test time.

## OPERATION

### Instructions for Use

 **WARNING:** Always observe the safety instructions and applicable regulations.

 **WARNING:** To reduce the risk of serious personal injury, turn tool off and disconnect tool from power source before making any adjustments or removing/

installing attachments or accessories. Be sure the trigger switch is in the OFF position. An accidental start-up can cause injury.



### WARNING:

- Ensure all materials to be ground or cut are secured in place.
- Secure and support the workpiece. Use clamps or a vice to hold and support the workpiece to a stable platform. It is important to clamp and support the workpiece securely to prevent movement of the workpiece and loss of control. Movement of the workpiece or loss of control may create a hazard and cause personal injury.
- **Support panels or any oversized workpiece to minimize the risk of wheel pinching and kickback.** Large workpieces tend to sag under their own weight. Supports must be placed under the workpiece near the line of cut and near the edge of the workpiece on both sides of the wheel.
- Always wear regular working gloves while operating this tool.
- The gear becomes very hot during use.
- Apply only a gentle pressure to the tool. Do not exert side pressure on the disc.
- Always install the guard and appropriate disc or wheel. Do not use excessively worn disc or wheel.
- Be sure the inner and outer flange are mounted correctly.
- Make sure the disc or wheel rotates in the direction of the arrows on the accessory and the tool.
- Avoid overloading. Should the tool become hot, let it run a few minutes under no load condition to cool the accessory. Do not touch accessories before they have cooled. The discs become very hot during use.
- Never work with the grinding cup without a suitable protection guard in place.
- Do not use the power tool with a cut-off stand.
- Never use blotters together with bonded abrasive products.
- Be aware, the wheel continues to rotate after the tools is switched off.

## Proper Hand Position (Fig. G)



**WARNING:** To reduce the risk of serious personal injury, ALWAYS use proper hand position as shown.



**WARNING:** To reduce the risk of serious personal injury, ALWAYS hold securely in anticipation of a sudden reaction.

Proper hand position requires one hand on the side handle , with the other hand on the body of the tool, as shown in Figure G.

## Variable Speed Dial (Fig. A)

DWE4246, DWE4257

The variable speed dial offers added tool control and enables the tool to be used at optimum conditions to suit the accessory and material.

- Turn the dial **8** to the desired level. Turn the dial upward for higher speed and downwards for lower speed.

## Slider Switch (Fig. A)



**CAUTION:** Hold the side handle and body of the tool firmly to maintain control of the tool at start up and during use and until the wheel or accessory stops rotating. Make sure the wheel has come to a complete stop before laying the tool down.

**NOTE:** To reduce unexpected tool movement, do not switch the tool on or off while under load conditions. Allow the grinder to run up to full speed before touching the work surface. Lift the tool from the surface before turning the tool off. Allow the tool to stop rotating before putting it down.



**WARNING:** Before connecting the tool to a power supply, be sure the slider switch is in the off position by pressing the rear part of the switch and releasing. Ensure the slider switch is in the off position as described above after any interruption in power supply to the tool, such as the activation of a ground fault interrupter, throwing of a circuit breaker, accidental unplugging, or power failure. If the slider switch is locked on when the power is connected, the tool will start unexpectedly.

To start the tool, slide the ON/OFF slider switch **7** toward the front of the tool. To stop the tool, release the ON/OFF slider switch.

For continuous operation, slide the switch toward the front of the tool and press the forward part of the switch inward. To stop the tool while operating in continuous mode, press the rear part of the slider switch and release.

## Spindle Lock Button (Fig. B)

The spindle lock button **1** is provided to prevent the spindle from rotating when installing or removing wheels. Operate the spindle lock button only when the tool is turned off, unplugged from the power supply, and has come to a complete stop.

**NOTICE:** To reduce the risk of damage to the tool, do not engage the spindle lock while the tool is operating. Damage to the tool will result and attached accessory may spin off possibly resulting in injury.

To engage the lock, depress the spindle lock button and rotate the spindle until you are unable to rotate the spindle further.

## Surface Grinding, Sanding and

### Wire Brushing



**CAUTION:** Always use the correct guard per the instructions in this manual.



**WARNING: Metal dust build-up.** Extensive use of flap discs in metal applications can result in the increased potential for electric shock. To reduce this risk, insert an

RCD before use and clean the ventilation slots daily by blowing dry compressed air into the ventilation slots in accordance with the below maintenance instructions.

To perform work on a the surface of a workpiece:

1. Allow the tool to reach full speed before touching the tool to the work surface.
2. Apply minimum pressure to the work surface, allowing the tool to operate at high speed. Material removal rate is greatest when the tool operates at high speed.

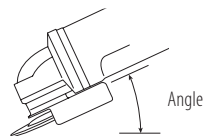

3. Maintain an appropriate angle between the tool and work surface. Refer to the chart according to particular function.

Function	Angle
Grinding	20° -30°
Sanding with Flap Disc	5° -10°
Sanding with Backing Pad	5° -15°
Wire Brushing	5° -10°

4. Maintain contact between the edge of the wheel and the work surface.
  - If grinding, sanding with flap discs or wire brushing move the tool continuously in a forward and back motion to avoid creating gouges in the work surface.
  - If sanding with a backing pad, move the tool constantly in a straight line to prevent burning and swirling of work surface.

**NOTE:** Allowing the tool to rest on the work surface without moving will damage the work piece.

5. Remove the tool from work surface before turning tool off. Allow the tool to stop rotating before laying it down.



**CAUTION:** Use extra care when working over an edge, as a sudden sharp movement of grinder may be experienced.

## Precautions To Take When Working on a Painted Workpiece

1. Sanding or wire brushing of lead based paint is NOT RECOMMENDED due to the difficulty of controlling the contaminated dust. The greatest danger of lead poisoning is to children and pregnant women.
2. Since it is difficult to identify whether or not a paint contains lead without a chemical analysis, we recommend the following precautions when sanding any paint:

### Personal Safety

1. No children or pregnant women should enter the work area where the paint sanding or wire brushing is being done until all clean up is completed.
2. A dust mask or respirator should be worn by all persons entering the work area. The filter should be replaced daily or whenever the wearer has difficulty breathing.

**NOTE:** Only those dust masks suitable for working with lead paint dust and fumes should be used. Ordinary painting masks do not offer this protection. See your local hardware dealer for the proper N.I.O.S.H. approved mask.

3. NO EATING, DRINKING or SMOKING should be done in the work area to prevent ingesting contaminated paint particles. Workers should wash and clean up BEFORE eating, drinking or smoking. Articles of food, drink, or smoking should not be left in the work area where dust would settle on them.

### Environmental Safety

1. Paint should be removed in such a manner as to minimize the amount of dust generated.
2. Areas where paint removal is occurring should be sealed with plastic sheeting of 4 mils thickness.
3. Sanding should be done in a manner to reduce tracking of paint dust outside the work area.

### Cleaning and Disposal

1. All surfaces in the work area should be vacuumed and thoroughly cleaned daily for the duration of the sanding project. Vacuum filter bags should be changed frequently.
2. Plastic drop cloths should be gathered up and disposed of along with any dust chips or other removed debris. They should be placed in sealed refuse receptacles and disposed of through regular trash pick-up procedures. During clean up, children and pregnant women should be kept away from the immediate work area.
3. All toys, washable furniture and utensils used by children should be washed thoroughly before being used again.

### Edge Grinding and Cutting



**WARNING:** Do not use edge grinding/cutting wheels for surface grinding applications because these wheels are not designed for side pressures encountered with surface grinding. Wheel breakage and injury may result.



**CAUTION:** Wheels used for edge grinding and cutting may break or kick back if they bend or twist while the tool is being used. In all edge grinding/cutting operations, the open side of the guard must be positioned away from the operator.

**NOTICE:** Edge grinding/cutting with a Type 27 wheel must be limited to shallow cutting and notching—less than 13 mm in depth when the wheel is new. Reduce the depth of cutting/notching equal to the reduction of the wheel radius as it wears down. Refer to the **Grinding and Cutting Accessory Chart** for more information. Edge grinding/cutting with a Type 41 wheel requires usage of a Type 1 guard.

1. Allow the tool to reach full speed before touching the tool to the work surface.
2. Apply minimum pressure to the work surface, allowing the tool to operate at high speed. Grinding/cutting rate is greatest when the tool operates at high speed.

3. Position yourself so that the open-underside of the wheel is facing away from you.
4. Once a cut is begun and a notch is established in the workpiece, do not change the angle of the cut. Changing the angle will cause the wheel to bend and may cause wheel breakage. Edge grinding wheels are not designed to withstand side pressures caused by bending.
5. Remove the tool from the work surface before turning the tool off. Allow the tool to stop rotating before laying it down.

### Metal Applications

When using the tool in metal applications, make sure that a residual current device (RCD) has been inserted to avoid residual risks caused by metal swarf.

If the power supply is shut off by the RCD, take the tool to an authorised DEWALT repair agent.



**WARNING:** In extreme working conditions, conductive dust can accumulate inside the machine housing when working with metal. This can result in the protective insulation in the machine becoming degraded with a potential risk of an electrical shock.

To avoid build-up of metal swarf inside the machine, we recommend to clear the ventilation slots on a daily basis. Refer to **Maintenance**.

### Cutting Metal

**For cutting with bonded abrasives, always use the guard type 1.**

When cutting, work with moderate feed, adapted to the material being cut. Do not exert pressure onto the cutting disc, tilt or oscillate the machine.

Do not reduce the speed of running down cutting discs by applying sideward pressure.

The machine must always work in an upgrinding motion. Otherwise, the danger exists of it being pushed uncontrolled out of the cut.

When cutting profiles and square bar, it is best to start at the smallest cross section.

### Rough Grinding

**Never use a cutting disc for roughing.**

**Always use the guard type 27.**

The best roughing results are achieved when setting the machine at an angle of 30° to 40°. Move the machine back and forth with moderate pressure. In this manner, the workpiece will not become too hot, does not discolour and no grooves are formed.

### Cutting Stone

**The machine shall be used only for dry cutting.**

For cutting stone, it is best to use a diamond cutting disc.

Operate the machine only with additional dust protection mask.

## Working Advice

### Exercise caution when cutting slots in structural walls.

Slots in structural walls are subject to the country-specific regulations. These regulations are to be observed under all circumstances. Before beginning work, consult the responsible structural engineer, architect or the construction supervisor.

## MAINTENANCE

Your DeWALT power tool has been designed to operate over a long period of time with a minimum of maintenance. Continuous satisfactory operation depends upon proper tool care and regular cleaning.



**WARNING:** To reduce the risk of serious personal injury, turn tool off and disconnect tool from power source before making any adjustments or removing/installing attachments or accessories. Be sure the trigger switch is in the OFF position. An accidental start-up can cause injury.

## Pop-off Brushes

The motor will be automatically shut off indicating that the carbon brushes are nearly worn out and that the tool needs servicing. The carbon brushes are not user-serviceable. Take the tool to an authorised DeWALT repair agent.



## Lubrication

Your power tool requires no additional lubrication.



## Cleaning



**WARNING:** Blow dirt and dust out of the main housing with dry air as often as dirt is seen collecting in and around the air vents. Wear approved eye protection and approved dust mask when performing this procedure.



**WARNING:** Never use solvents or other harsh chemicals for cleaning the non-metallic parts of the tool. These chemicals may weaken the materials used in these parts. Use a cloth dampened only with water and mild soap. Never let any liquid get inside the tool; never immerse any part of the tool into a liquid.

## Optional Accessories



**WARNING:** Since accessories, other than those offered by DeWALT, have not been tested with this product, use of such accessories with this tool could be hazardous. To reduce the risk of injury, only DeWALT recommended accessories should be used with this product.

Consult your dealer for further information on the appropriate accessories.

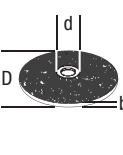
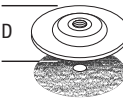
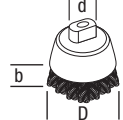
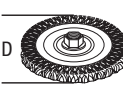
	Max. [mm]		[mm]	Min. Rotation [min. <sup>-1</sup> ]	Peripheral speed [m/s]	Threaded hole length [mm]
	D	b	d			
	115	6	22,23	11500	80	–
	125	6	22,23	11500	80	–
	150	6	22,23	9300	80	–
	115	–	–	11500	80	–
	125	–	–	11500	80	–
	75	30	M14	11500	45	20.0
	115	12	M14	11500	80	20.0
	125	12	M14	11500	80	20.0

## Protecting the Environment













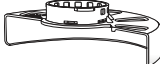



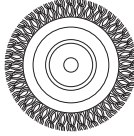

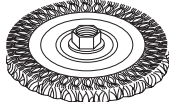
Separate collection. Products and batteries marked with this symbol must not be disposed of with normal household waste.





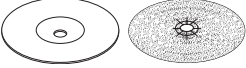

Products and batteries contain materials that can be recovered or recycled reducing the demand for raw materials. Please recycle electrical products and batteries according to local provisions. Further information is available at [www.2helpU.com](http://www.2helpU.com).

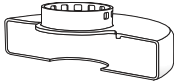
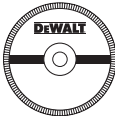
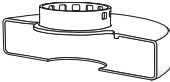

### Grinding and Cutting Accessory Chart

Guard Type	Accessory	Description	How to Fit Grinder
 Type 27 Guard		Depressed centre grinding disc	 Type 27 guard
		Flap wheel	 Backing flange
		Wire wheels	 Type 27 depressed centre wheel  Threaded clamp nut
		Wire wheels with threaded nut	 Type 27 guard  Wire wheel
		Wire cup with threaded nut	 Type 27 guard  Wire brush
		Backing pad/sanding sheet	 Type 27 guard  Rubber backing pad  Sanding disc  Threaded clamp nut

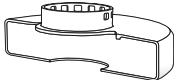
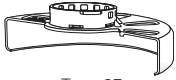
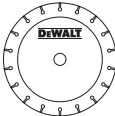
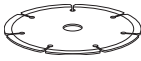
### Grinding and Cutting Accessory Chart (cont.)

Guard Type	Accessory	Description	How to Fit Grinder
 <p>Type 1 Guard</p>		<p>Masonry cutting disc, bonded</p>	 <p>Type 1 guard</p>
		<p>Metal cutting disc, bonded</p>	 <p>Backing flange</p>
 <p>Type 1 Guard</p> <p>OR</p>  <p>Type 27 Guard</p>		<p>Diamond cutting wheels</p>	 <p>Cutting wheel</p>  <p>Threaded clamp nut</p>



<b>Belgique et Luxembourg België en Luxemburg</b>	DeWALT - Belgium BVBA Egide Walschaertsstraat 16 2800 Mechelen	Tel: NL 32 15 47 37 63 Tel: FR 32 15 47 37 64 Fax: 32 15 47 37 99	www.dewalt.be enduser.BE@sbdinc.com
<b>Danmark</b>	DeWALT (Stanley Black&Decker AS) Roskildevej 22 2620 Albertslund	Tel: 70 20 15 10 Fax: 70 22 49 10	www.dewalt.dk kundeservice.dk@sbdinc.com
<b>Deutschland</b>	DeWALT Richard Klingner Str. 11 65510 Idstein	Tel: 06126-21-0 Fax: 06126-21-2770	www.dewalt.de infodwge@sbdinc.com
<b>Ελλάδα</b>	DeWALT (Ελλάδα) Α.Ε. ΕΔΡΑ-ΤΡΑΠΕΖΙΑ : Στραδίου 7 & Λ. Βουλιαγμένης, Γλυφάδα 166 74, Αθήνα SERVICE : Ημερος, Τόπος 2 (Χάιν Αόδου) – 193 00 Ασπρόπυργος	Τηλ: 00302108981616 Φαξ: 00302108983570	www.dewalt.gr Greece.Service@sbdinc.com
<b>España</b>	DeWALT Ibérica, S.C.A. Parc de Negocios "Mas Blau" Edificio Muntadas, c/Bergadà, 1, Of. A6 08820 El Prat de Llobregat (Barcelona)	Tel: 934 797 400 Fax: 934 797 419	www.dewalt.es respuesta.postventa@sbdinc.com
<b>France</b>	DeWALT 5, allée des Hêtres BP 60105, 69579 Limonest Cedex	Tel: 04 72 20 39 20 Fax: 04 72 20 39 00	www.dewalt.fr scuf@sbdinc.com
<b>Schweiz Suisse Svizzera</b>	DeWALT In der Luberzen 42 8902 Ürdorf	Tel: 044 - 755 60 70 Fax: 044 - 730 70 67	www.dewalt.ch service@rofaog.ch
<b>Ireland</b>	DeWALT Building 4500, Kinsale Road Cork Airport Business Park Cork, Ireland	Tel: 00353-2781800 Fax: 01278 1811	www.dewalt.ie Sales.ireland@sbdinc.com
<b>Italia</b>	DeWALT via Energypark 6 20871 Vimercate (MB), IT	Tel: 800-014353 39 039-9590200 Fax: 39 039-9590311	www.dewalt.it
<b>Nederlands</b>	DeWALT Netherlands BVPostbus 83, 6120 AB BORN	Tel: 31 164 283 063 Fax: 31 164 283 200	www.dewalt.nl
<b>Norge</b>	DeWALT Postboks 4613 0405 Oslo, Norge	Tel: 45 25 13 00 Fax: 45 25 08 00	www.dewalt.no kundeservice.no@sbdinc.com
<b>Österreich</b>	DeWALT Werkzeug Vertriebsges m.b.H Oberlaaerstrasse 248, A-1230 Wien	Tel: 01 - 66116 - 0 Fax: 01 - 66116 - 614	www.dewalt.at service.austria@sbdinc.com
<b>Portugal</b>	DeWALT Ed. D Dinis, Quina da Fonte Rua dos Malhoes 2 2A 2º Esq. Oeiras e S. Juliao da Barra, paço de Arcos e Caxias 2770 071 Paço de Arcos	Tel: +351 214667500 Fax: +351214667580	www.dewalt.pt resposta.posvenda@sbdinc.com
<b>Suomi</b>	DeWALT PL47 00521 Helsinki, Suomi	Puh: 010 400 4333 Faksi: 0800 411 340	www.dewalt.fi asiakaspalvelu.fi@sbdinc.com
<b>Sverige</b>	DeWALT BOX 94 43122 Mölndal Sverige	Tel: 031 68 61 60 Fax: 031 68 60 08	www.dewalt.se kundservice.se@sbdinc.com
<b>Türkiye</b>	Sanayi ve Ticareet Bakanlığı tebliğince kullanım ömrü 7 yıldır. Stanley Black & Decker Turkey Alet Üretim San. Tic. Ltd.Şti. Kozyatağı Mh Değirmen Sk. Nida Kule No: 18 Kat: 6, 34742 Kadıköy, İstanbul, Türkiye	Tel: +90 216 665 2900 Faks: +90 216 665 2901	www.dewalt.com.tr info-tr@sbdinc.com
<b>United Kingdom</b>	DeWALT, 210 Bath Road, Slough, Berks SL1 3YD	Tel: 01753-567055 Fax: 01753-572112	www.dewalt.co.uk emeservice@sbdinc.com
<b>Australia</b>	DeWALT 810 Whitehorse Road Box Hill VIC 3103 Australia	Tel: Aust 1800 338 002 Tel: NZ 0800 339 258	www.dewalt.com.au www.dewalt.co.nz
<b>Middle East Africa</b>	DeWALT P.O. Box - 17164, Jebel Ali Free Zone (South), Dubai, UAE	Tel: 971 4 812 7400 Fax: 971 4 2822765	www.dewalt.ae Service.MEA@sbdinc.com